

TABLE OF CONTENTS

Features	1	Register 1	17
Applications.....	1	Register 2	17
General Description	1	Register 3	19
Functional Block Diagram	1	Register 4	19
Revision History	2	Register 5	19
Specifications.....	3	Initialization Sequence	19
Timing Characteristics	5	RF Synthesizer—A Worked Example	20
Absolute Maximum Ratings.....	6	Modulus.....	20
Transistor Count.....	6	Reference Doubler and Reference Divider	20
ESD Caution.....	6	12-Bit Programmable Modulus.....	20
Pin Configuration and Function Descriptions.....	7	Cycle Slip Reduction for Faster Lock Times.....	21
Typical Performance Characteristics	9	Spurious Optimization and Fast lock	21
Circuit Description.....	11	Fast Lock Timer and Register Sequences.....	21
Reference Input Section.....	11	Fast Lock—An Example	22
RF N Divider.....	11	Fast Lock—Loop Filter Topology.....	22
INT, FRAC, MOD, and R Counter Relationship.....	11	Spur Mechanisms	22
INT N Mode.....	11	Spur Consistency and Fractional Spur Optimization	23
R Counter	11	Phase Resync.....	23
Phase Frequency Detector (PFD) and Charge Pump.....	11	Applications Information	24
MUXOUT and Lock Detect.....	12	Direct Conversion Modulator	24
Input Shift Registers	12	Interfacing	25
Program Modes	12	PCB Design Guidelines for Chip Scale Package	25
Register Maps.....	13	Outline Dimensions	26
Register 0	17	Ordering Guide	26

REVISION HISTORY

12/11—Rev. A to Rev. B

Changes to Normalized 1/f Noise Parameter, Table 1

11/11—Rev. 0 to Rev. A

Changes to Figure 28.....

10/11—Revision 0: Initial Version

SPECIFICATIONS

$AV_{DD} = DV_{DD} = SD_{VDD} = 3.3 \text{ V} \pm 10\%$; $V_P = AV_{DD}$ to 5.5 V ; $A_{GND} = D_{GND} = 0 \text{ V}$; $T_A = T_{MIN}$ to T_{MAX} , unless otherwise noted. Operating temperature range is -40°C to $+85^\circ\text{C}$.

Table 1.

Parameter	B Version			Unit	Conditions/Comments
	Min	Typ	Max		
REF _{IN} CHARACTERISTICS					
Input Frequency	10		250	MHz	For $f < 10 \text{ MHz}$, ensure slew rate $> 21 \text{ V}/\mu\text{s}$ Biased at $AV_{DD}/2^1$
Input Sensitivity	0.7		AV_{DD}	V p-p	
Input Capacitance		10		pF	
Input Current			± 60	μA	
RF INPUT CHARACTERISTICS					
RF Input Frequency (RF _{IN})	0.5		3.5	GHz	For lower frequencies, ensure slew rate $> 400 \text{ V}/\mu\text{s}$ $-10 \text{ dBm} \leq \text{RF input power} \leq +5 \text{ dBm}$
Prescaler Output Frequency			750	MHz	
MAXIMUM PFD FREQUENCY					
Fractional-N Mode					
Low Spur Mode			26	MHz	
Low Noise Mode			32	MHz	
Integer-N Mode			32	MHz	
CHARGE PUMP					
I _{CP} Sink/Source					$R_{SET} = 5.1 \text{ k}\Omega$
High Value		4.5		mA	
Low Value		0.281		mA	$V_{CP} = V_P/2$ $0.5 \text{ V} \leq V_{CP} \leq V_P - 0.5 \text{ V}$ $0.5 \text{ V} \leq V_{CP} \leq V_P - 0.5 \text{ V}$ $V_{CP} = V_P/2$
R _{SET} Range	2.7		10	k Ω	
I _{CP} Leakage		1		nA	
Sink and Source Matching		2		%	
I _{CP} vs. V _{CP}		1.5		%	
I _{CP} vs. Temperature		2		%	
LOGIC INPUTS					
Input High Voltage, V _{INH}	1.5			V	
Input Low Voltage, V _{INL}			0.6	V	
Input Current, I _{INH} /I _{INL}			± 1	μA	
Input Capacitance, C _{IN}		5.0		pF	
LOGIC OUTPUTS					
Output High Voltage, V _{OH}	$DV_{DD} - 0.4$			V	CMOS output chosen $I_{OL} = 500 \mu\text{A}$
Output High Current, I _{OH}			500	μA	
Output Low Voltage, V _O			0.4	V	
POWER SUPPLIES					
AV _{DD}	3.0		3.6	V	$V_P = 5 \text{ V}$
DV _{DD} , SD _{VDD}		AV_{DD}			
V _P	AV_{DD}		5.5	V	
D _{I_{DD}} + A _{I_{DD}} ²		40	50	mA	
V _{P_{I_{DD}}} ²		2		mA	
Low Power Sleep Mode		1		μA	

Parameter	B Version			Unit	Conditions/Comments
	Min	Typ	Max		
NOISE CHARACTERISTICS					
Normalized In-Band Phase Noise Floor (PN _{SYNTH}) ³		-221		dBc/Hz	PLL loop BW = 500 kHz (ABP = 3 ns)
Normalized 1/f Noise (PN _{1-f}) ⁴		-118		dBc/Hz	10 kHz offset. Normalized to 1 GHz (ABP = 3 ns)
Normalized In-Band Phase Noise Floor (PN _{SYNTH}) ³		-220		dBc/Hz	PLL loop BW = 500 kHz (ABP = 6 ns); low noise mode
Normalized 1/f Noise (PN _{1-f}) ⁴		-115		dBc/Hz	10 kHz offset; normalized to 1 GHz (ABP = 6 ns); low noise mode
Spurious Signals Due to PFD Frequency ⁵		-107		dBc	PFD = 25 MHz

¹ AC coupling ensures AV_{DD}/2 bias.

² T_A = 25°C; AV_{DD} = DV_{DD} = 3.6 V; prescaler = 4/5; f_{REFIN} = 130 MHz; f_{PFD} = 26 MHz; f_{RF} = 1.742 GHz.

³ The synthesizer phase noise floor is estimated by measuring the in-band phase noise at the output of the VCO and subtracting 20 log N (where N is the N divider value) and 10 log F_{PFD}. PN_{SYNTH} = PN_{TOT} - 10 log f_{PFD} - 20 log N

⁴ The PLL phase noise is composed of 1/f (flicker) noise plus the normalized PLL noise floor. The formula for calculating the 1/f noise contribution at an RF frequency (f_{RF}) and at a frequency offset (f) is given by PN = P_{1-f} + 10 log(10 kHz/f) + 20 log(f_{RF}/1 GHz). Both the normalized phase noise floor and flicker noise are modeled in ADIsimPLL.

⁵ Spurious measured on EVAL-ADF4151EB1Z with RF buffer between VCO output and RF input by-passed, using a Rohde & Schwarz FSUP signal source analyzer.

TIMING CHARACTERISTICS

$AV_{DD1}, AV_{DD2} = DV_{DD} = SD_{VDD} = 3.3\text{ V} \pm 10\%$; $V_P = AV_{DD}$ to 5.5 V; $A_{GND} = D_{GND} = 0\text{ V}$; $T_A = T_{MIN}$ to T_{MAX} , unless otherwise noted. Operating temperature range is -40°C to $+85^\circ\text{C}$.

Table 2.

Parameter	Limit (B Version)	Unit	Test Conditions/Comments
t_1	20	ns min	LE setup time
t_2	10	ns min	DATA to CLK setup time
t_3	10	ns min	DATA to CLK hold time
t_4	25	ns min	CLK high duration
t_5	25	ns min	CLK low duration
t_6	10	ns min	CLK to LE setup time
t_7	20	ns min	LE pulse width

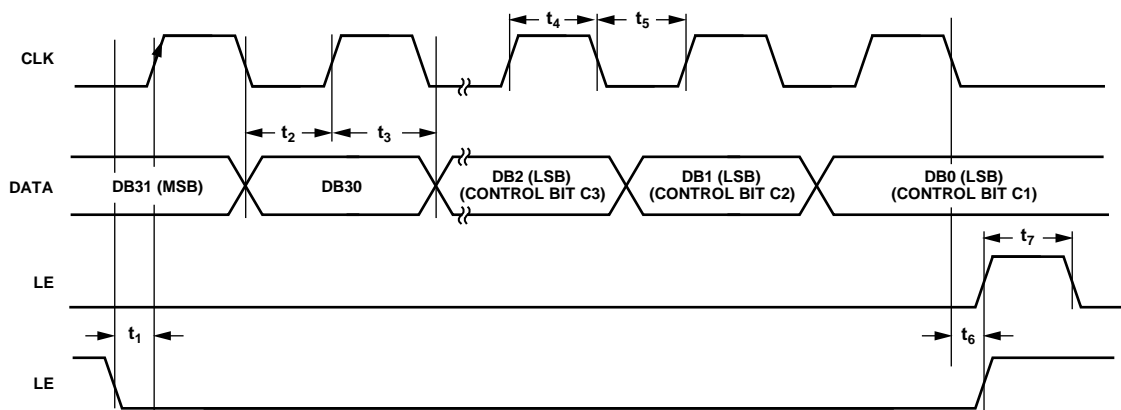

Figure 2. Timing Diagram

10285-002

ABSOLUTE MAXIMUM RATINGS

$T_A = 25^\circ\text{C}$, unless otherwise noted.

Table 3.

Parameter	Rating
AV_{DD1} , AV_{DD2} to GND ¹	-0.3 V to +3.9 V
AV_{DD1} , AV_{DD2} to DV_{DD}	-0.3 V to +0.3 V
V_P to AV_{DD1} , AV_{DD2}	-0.3 V to +5.8 V
Digital I/O Voltage to GND ¹	-0.3 V to $V_{DD} + 0.3$ V
Analog I/O Voltage to GND ¹	-0.3 V to $V_{DD} + 0.3$ V
REF_{IN} to GND ¹	-0.3 V to $V_{DD} + 0.3$ V
Operating Temperature Range	-40°C to +85°C
Storage Temperature Range	-65°C to +125°C
Maximum Junction Temperature	150°C
LFCSP θ_{JA} Thermal Impedance (Paddle-Soldered)	27.3°C/W
Reflow Soldering	
Peak Temperature	260°C
Time at Peak Temperature	40 sec

¹GND = A_{GND} = D_{GND} = 0 V.

Stresses above those listed under Absolute Maximum Ratings may cause permanent damage to the device. This is a stress rating only; functional operation of the device at these or any other conditions above those indicated in the operational section of this specification is not implied. Exposure to absolute maximum rating conditions for extended periods may affect device reliability.

TRANSISTOR COUNT

36685 (CMOS) and 967 (bipolar)

ESD CAUTION



ESD (electrostatic discharge) sensitive device. Charged devices and circuit boards can discharge without detection. Although this product features patented or proprietary protection circuitry, damage may occur on devices subjected to high energy ESD. Therefore, proper ESD precautions should be taken to avoid performance degradation or loss of functionality.

PIN CONFIGURATION AND FUNCTION DESCRIPTIONS

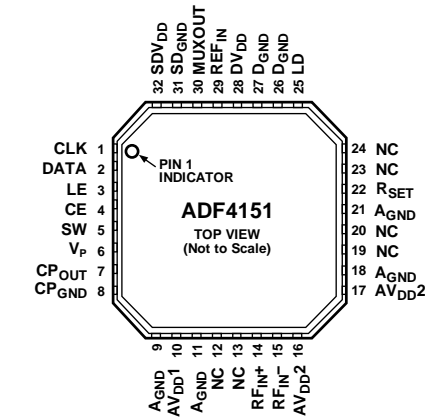

- NOTES
1. NC = NO CONNECT. DO NOT CONNECT TO THIS PIN.
 2. THE LFCSP HAS AN EXPOSED PADDLE THAT MUST BE CONNECTED TO GND.

10285-003

Figure 3. Pin Configuration

Table 4. Pin Function Descriptions

Pin No.	Mnemonic	Description
1	CLK	Serial Clock Input. Data is clocked into the 32-bit shift register on the CLK rising edge. This input is a high impedance CMOS input.
2	DATA	Serial Data Input. The serial data is loaded, MSB first, with the three LSBs as the control bits. This input is a high impedance CMOS input.
3	LE	Load Enable, CMOS Input. When LE goes high, the data stored in the shift register is loaded into the register that is selected by the three LSBs.
4	CE	Chip Enable. A logic low on this pin powers down the device and puts the charge pump into three-state mode. Taking the pin high powers up the device depending on the status of the power-down bits.
5	SW	Fast Lock Switch. Make a connection to this pin from the loop filter when using the fast lock mode.
6	V _P	Charge Pump Power Supply. This pin should be greater than or equal to AV _{DD} . In systems where AV _{DDX} is 3 V, it can be set to 5.5 V and used to drive a VCO with a tuning range of up to 5.5 V.
7	CP _{OUT}	Charge Pump Output. When enabled, this provides ±I _{CP} to the external loop filter. The output of the loop filter is connected to V _{TUNE} to drive the external VCO.
8	CP _{GND}	Charge Pump Ground. This is the ground return pin for CP _{OUT} .
9, 11, 18, 21	AGND	Analog Ground. This is a ground return pin for AV _{DD1} and AV _{DD2} .
10	AV _{DD1}	Analog Power Supply. This pin ranges from 3.0 V to 3.6 V. Decoupling capacitors to the analog ground plane are to be placed as close as possible to this pin. AV _{DD} must have the same value as DV _{DD} .
12, 13, 19, 20, 23, 24	NC	No connect. Do not connect to this pin.
14	RF _{IN+}	Input to the RF Input. This small signal input is ac-coupled to the external VCO.
15	RF _{IN-}	Complementary Input to the RF Input. This pin must be decoupled to the ground plane with a small bypass capacitor, typically 100 pF.
16, 17	AV _{DD2}	Analog Power Supply. This pin ranges from 3.0 V to 3.6 V. Decoupling capacitors to the analog ground plane are to be placed as close as possible to this pin. AV _{DDX} must have the same value as DV _{DD} .

Pin No.	Mnemonic	Description
22	R _{SET}	Connecting a resistor between this pin and GND sets the charge pump output current. The nominal voltage bias at the R _{SET} pin is 0.49 V. The relationship between I _{CP} and R _{SET} is $I_{CP} = \frac{22.95}{R_{SET}}$ where: R _{SET} = 5.1 kΩ. I _{CP} = 4.5 mA.
25	LD	Lock Detect Output Pin. This pin outputs a logic high to indicate PLL lock; a logic low output indicates loss of PLL lock.
26, 27	D _{GND}	Digital Ground. Ground return path for DV _{DD} .
28	DV _{DD}	Digital Power Supply. This pin should be the same voltage as AV _{DD} . Decoupling capacitors to the ground plane should be placed as close as possible to this pin.
29	REF _{IN}	Reference Input. This is a CMOS input with a nominal threshold of V _{DD} /2 and a dc equivalent input resistance of 100 kΩ. This input can be driven from a TTL or CMOS crystal oscillator, or it can be ac-coupled.
30	MUXOUT	Multiplexer Output. This multiplexer output allows either the lock detect, the scaled RF, or the scaled reference frequency to be accessed externally.
31	SD _{GND}	Digital Sigma-Delta (Σ-Δ) Modulator Ground. Ground return path for the Σ-Δ modulator.
32	SDV _{DD}	Power Supply Pin for the Digital Σ-Δ Modulator. Should be the same voltage as AV _{DDX} . Decoupling capacitors to the ground plane are to be placed as close as possible to this pin.
	EP	The exposed pad must be connected to GND.

TYPICAL PERFORMANCE CHARACTERISTICS

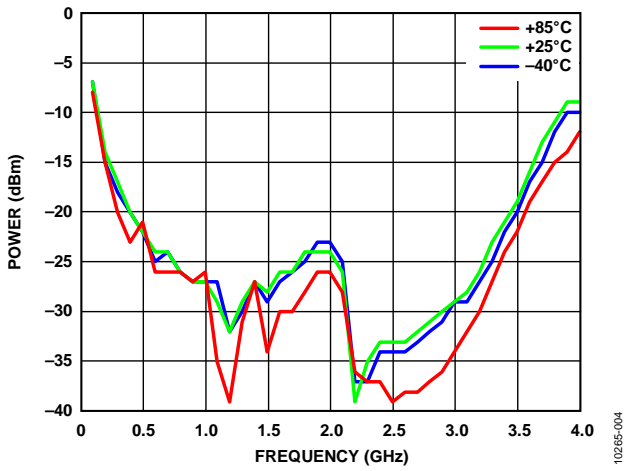

Figure 4. RF Input Sensitivity

10265-004

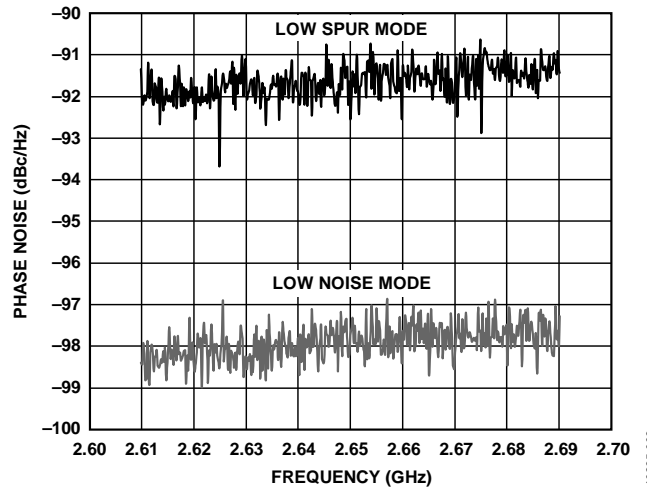

Figure 6. In-Band Phase Noise Measured at 10 kHz Offset for Low Noise Mode and Low Spur Mode, PFD = 25 MHz, PLL Loop Bandwidth = 50 kHz

10265-006

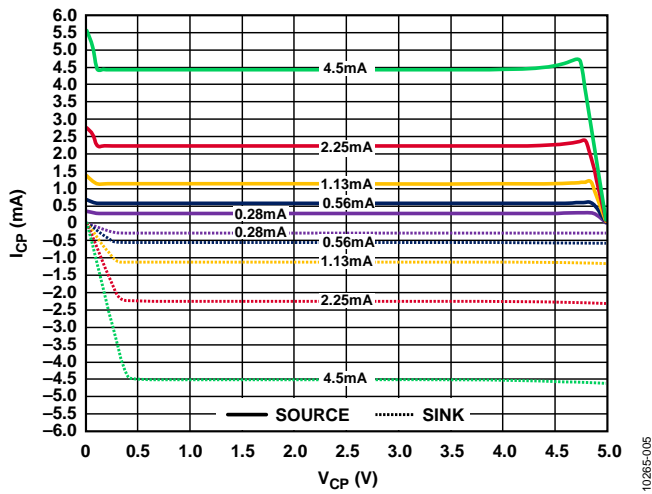

Figure 5. Charge Pump Output Characteristics, $V_P = 5\text{ V}$, Selected I_{CP} Values Between 0.28 mA (Min) and 4.5 mA (Max), $R_{SET} = 5.1\text{ k}\Omega$

10265-005

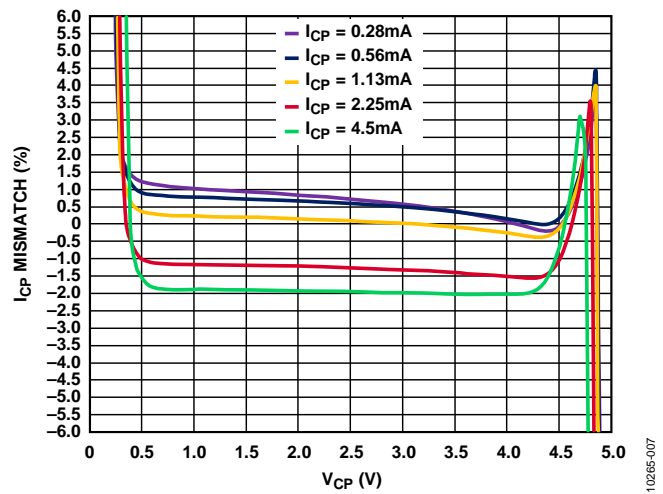

Figure 7. Charge Pump Output Mismatch vs. V_{CP} , Selected I_{CP} Values Between 0.28 mA (Min) and 4.5 mA (Max), $R_{SET} = 5.1\text{ k}\Omega$

10265-007

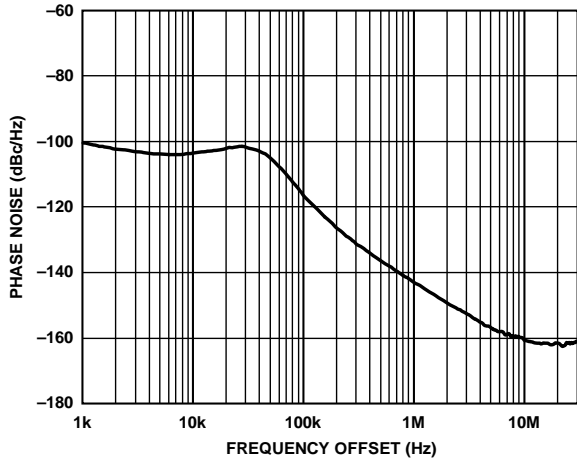

Figure 8. Integer-N Phase Noise and Spur Performance; Low Noise Mode; $V_{CO_{OUT}} = 1750$ MHz, $REF_{IN} = 100$ MHz, PFD = 25 MHz, Loop Filter Bandwidth = 50 kHz

10265-008

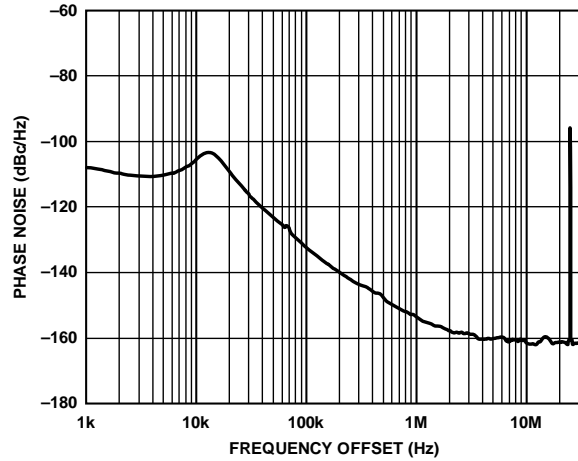

Figure 11. Integer-N Phase Noise and Spur Performance; Low Noise Mode; $V_{CO_{OUT}} = 900$ MHz, $REF_{IN} = 100$ MHz, PFD = 25 MHz, Loop Filter Bandwidth = 20 kHz

10265-011

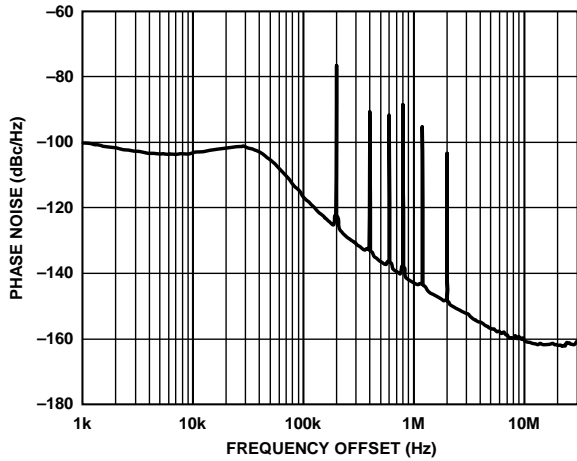

Figure 9. Fractional-N Phase Noise and Spur Performance; Low Noise Mode; $V_{CO_{OUT}} = 1755.2$ MHz, $REF_{IN} = 100$ MHz, PFD = 25 MHz, Loop Filter Bandwidth = 50 kHz, Channel Spacing = 200 kHz, FRAC = 26, MOD = 125

10265-009

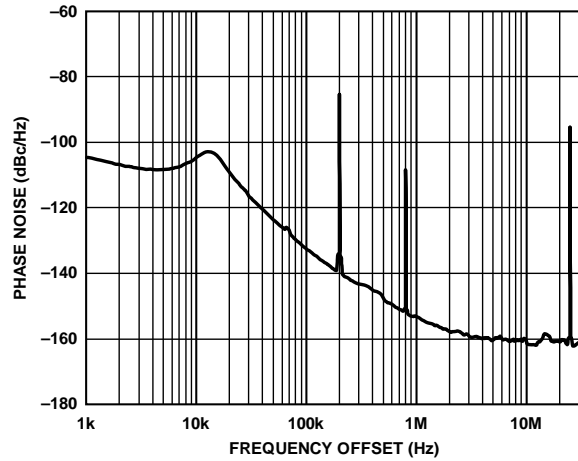

Figure 12. Fractional-N Phase Noise and Spur Performance; Low Noise Mode; $V_{CO_{OUT}} = 905.2$ MHz, $REF_{IN} = 100$ MHz, PFD = 25 MHz, Loop Filter Bandwidth = 20 kHz, Channel Spacing = 200 kHz, FRAC = 26, MOD = 125

10265-012

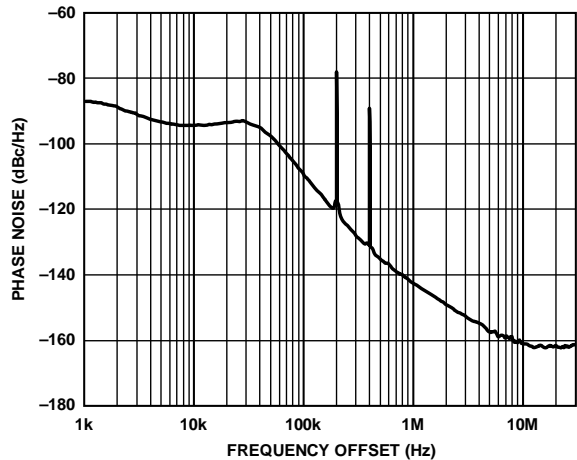

Figure 10. Fractional-N Phase Noise and Spur Performance; Low Spur Mode; $V_{CO_{OUT}} = 1755.2$ MHz, $REF_{IN} = 100$ MHz, PFD = 25 MHz, Loop Filter Bandwidth = 50 kHz, Channel Spacing = 200 kHz, FRAC = 26, MOD = 125

10265-010

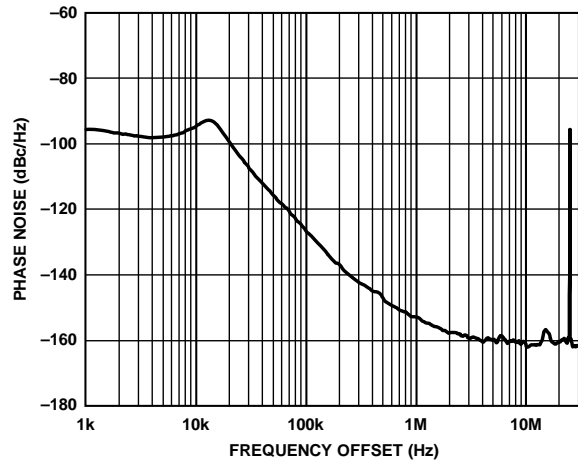

Figure 13. Fractional-N Phase Noise and Spur Performance; Low Spur Mode; $V_{CO_{OUT}} = 905.2$ MHz, $REF_{IN} = 100$ MHz, PFD = 25 MHz, Loop Filter Bandwidth = 20 kHz, Channel Spacing = 200 kHz, FRAC = 26, MOD = 125

10265-013

CIRCUIT DESCRIPTION

REFERENCE INPUT SECTION

The reference input stage is shown in Figure 14. SW1 and SW2 are normally closed switches. SW3 is normally open. When power-down is initiated, SW3 is closed and SW1 and SW2 are opened. This ensures that there is no loading of the REF_{IN} pin on power-down.

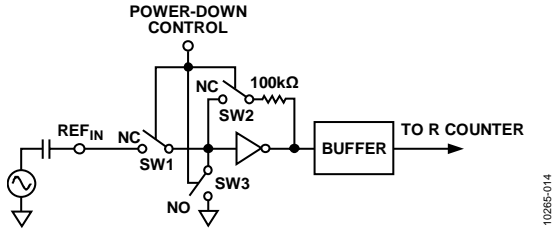

Figure 14. Reference Input Stage

RF N DIVIDER

The RF N divider allows a division ratio in the PLL feedback path. Division ratio is determined by the INT, FRAC, and MOD values, which build up this divider.

INT, FRAC, MOD, AND R COUNTER RELATIONSHIP

The INT, FRAC, and MOD values, in conjunction with the R counter, make it possible to generate output frequencies that are spaced by fractions of the PFD frequency. See the RF Synthesizer—A Worked Example section for more information. The RF VCO frequency (RF_{OUT}) equation is

$$RF_{OUT} = f_{PFD} \times (INT + (FRAC/MOD)) \quad (1)$$

where:

RF_{OUT} is the output frequency of the external voltage controlled oscillator (VCO).

INT is the preset divide ratio of the binary 16-bit counter (23 to 32,767 for 4/5 prescaler, 75 to 65,535 for 8/9 prescaler).
 FRAC is the numerator of the fractional division (0 to MOD – 1).
 MOD is the preset fractional modulus (2 to 4095 for low noise mode, 50 to 4095 for low spur mode).

$$f_{PFD} = REF_{IN} \times [(1 + D)/(R \times (1 + T))] \quad (2)$$

where:

REF_{IN} is the reference input frequency.

D is the REF_{IN} doubler bit.

R is the preset divide ratio of the binary 10-bit programmable reference counter (1 to 1023).

T is the REF_{IN} divide-by-2 bit (0 or 1).

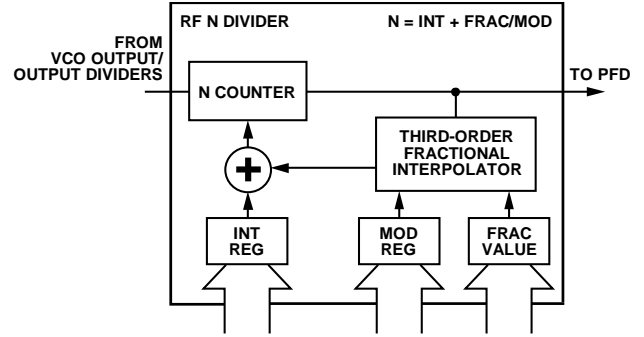

Figure 15. RF INT Divider

INT N MODE

If the FRAC = 0 and DB8 in Register 2 (LDF) is set to 1, the synthesizer operates in integer-N mode. The DB8 in Register 2 (LDF) should be set to 1 to get integer-N digital lock detect. Additionally, lower phase noise is possible if the antibacklash pulse width is reduced to 3 ns. This mode is not valid for fractional-N applications.

R COUNTER

The 10-bit R counter allows the input reference frequency (REF_{IN}) to be divided down to produce the reference clock to the PFD. Division ratios from 1 to 1023 are allowed.

PHASE FREQUENCY DETECTOR (PFD) AND CHARGE PUMP

The phase frequency detector (PFD) takes inputs from the R counter and N counter and produces an output proportional to the phase and frequency difference between them. Figure 16 is a simplified schematic of the phase frequency detector. The PFD includes a programmable delay element that sets the width of the antibacklash pulse, which can be either 6 ns (default, for fractional-N applications) or 3 ns (for integer-N mode). This pulse ensures that there is no dead zone in the PFD transfer function and gives a consistent reference spur level.

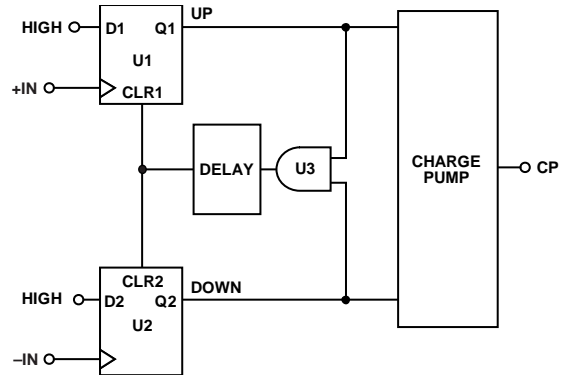

Figure 16. PFD Simplified Schematic

MUXOUT AND LOCK DETECT

The output multiplexer on the [ADF4151](#) allows the user to access various internal points on the chip. The state of MUXOUT is controlled by M3, M2, and M1 (for details, see Figure 21). Figure 17 shows the MUXOUT section in block diagram form.

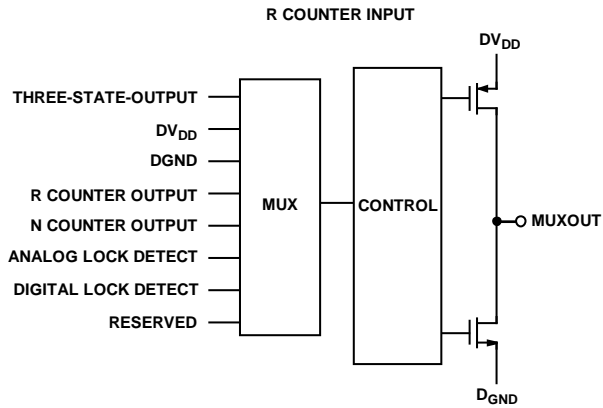

Figure 17. MUXOUT Schematic

INPUT SHIFT REGISTERS

The [ADF4151](#) digital section includes a 10-bit RF R counter, a 16-bit RF N counter, a 12-bit FRAC counter, and a 12-bit modulus counter. Data is clocked into the 32-bit shift register on each rising edge of CLK. The data is clocked in MSB first. Data is transferred from the shift register to one of six latches on the rising edge of LE. The destination latch is determined by the state of the three control bits (C3, C2, and C1) in the

shift register. There are three LSBs: DB2, DB1, and DB0, as shown in Figure 2. The truth table for these bits is shown in Table 5. Figure 18 shows a summary of how the latches are programmed.

Table 5. C3, C2, and C1 Truth Table

Control Bits			Register
C3	C2	C1	
0	0	0	Register 0 (R0)
0	0	1	Register 1 (R1)
0	1	0	Register 2 (R2)
0	1	1	Register 3 (R3)
1	0	0	Register 4 (R4)
1	0	1	Register 5 (R5)

PROGRAM MODES

Figure 19 through Figure 24 show how the program modes are to be set up in the [ADF4151](#).

A number of settings in the [ADF4151](#) are double buffered. These include the modulus value, phase value, R counter value, reference doubler, reference divide-by-2, and current setting. This means that two events must occur before the part uses a new value of any of the double-buffered settings. First, the new value is latched into the device by writing to the appropriate register. Second, a new write must be performed on Register R0. For example, any time the modulus value is updated, Register R0 must be written to, thus ensuring that the modulus value is loaded correctly.

REGISTER MAPS

REGISTER 0

RESERVED	16-BIT INTEGER VALUE (INT)															12-BIT FRACTIONAL VALUE (FRAC)											CONTROL BITS					
	DB31	DB30	DB29	DB28	DB27	DB26	DB25	DB24	DB23	DB22	DB21	DB20	DB19	DB18	DB17	DB16	DB15	DB14	DB13	DB12	DB11	DB10	DB9	DB8	DB7	DB6	DB5	DB4	DB3	DB2	DB1	DB0
	0	N16	N15	N14	N13	N12	N11	N10	N9	N8	N7	N6	N5	N4	N3	N2	N1	F12	F11	F10	F9	F8	F7	F6	F5	F4	F3	F2	F1	C3(0)	C2(0)	C1(0)

REGISTER 1

RESERVED	PHASE ADJUST	PRESCALER	12-BIT PHASE VALUE (PHASE) DBR ¹													12-BIT MODULUS VALUE (MOD) DBR ¹											CONTROL BITS							
			DB31	DB30	DB29	DB28	DB27	DB26	DB25	DB24	DB23	DB22	DB21	DB20	DB19	DB18	DB17	DB16	DB15	DB14	DB13	DB12	DB11	DB10	DB9	DB8	DB7	DB6	DB5	DB4	DB3	DB2	DB1	DB0
			0	0	0	PH1	PR1	P12	P11	P10	P9	P8	P7	P6	P5	P4	P3	P2	P1	M12	M11	M10	M9	M8	M7	M6	M5	M4	M3	M2	M1	C3(0)	C2(0)	C1(1)

REGISTER 2

RESERVED	LOW NOISE AND LOW SPUR MODES	MUXOUT	REFERENCE DOUBLER DBR ¹	RDIV2 DBR ¹	10-BIT R COUNTER DBR ¹													RESERVED	CHARGE PUMP CURRENT SETTING DBR ¹	LDF	LDP	PD POLARITY	POWER-DOWN	CP THREE-STATE COUNTER RESET	CONTROL BITS																		
					DB31	DB30	DB29	DB28	DB27	DB26	DB25	DB24	DB23	DB22	DB21	DB20	DB19								DB18	DB17	DB16	DB15	DB14	DB13	DB12	DB11	DB10	DB9	DB8	DB7	DB6	DB5	DB4	DB3	DB2	DB1	DB0
					0	L2	L1	M3	M2	M1	RD2	RD1	R10	R9	R8	R7	R6								R5	R4	R3	R2	R1	0	CP4	CP3	CP2	CP1	U6	U5	U4	U3	U2	U1	C3(0)	C2(1)	C1(0)

REGISTER 3

RESERVED													ABP	CHARGE CANCEL	RESERVED			CSR	RESERVED	CLK DIV MODE	12-BIT CLOCK DIVIDER VALUE											CONTROL BITS				
DB31	DB30	DB29	DB28	DB27	DB26	DB25	DB24	DB23	DB22	DB21	DB20	DB19			DB18	DB17	DB16				DB15	DB14	DB13	DB12	DB11	DB10	DB9	DB8	DB7	DB6	DB5	DB4	DB3	DB2	DB1	DB0
0	0	0	0	0	0	0	0	0	0	F3	F2	0			0	F1	0				C2	C1	D12	D11	D10	D9	D8	D7	D6	D5	D4	D3	D2	D1	C3(0)	C2(1)

REGISTER 4

RESERVED																											CONTROL BITS						
DB31	DB30	DB29	DB28	DB27	DB26	DB25	DB24	DB23	DB22	DB21	DB20	DB19	DB18	DB17	DB16	DB15	DB14	DB13	DB12	DB11	DB10	DB9	DB8	DB7	DB6	DB5	DB4	DB3	DB2	DB1	DB0		
0	0	0	0	0	0	0	0	0	1	0	0	0	0	0	0	0	0	0	0	0	0	0	0	0	0	0	0	0	0	0	C3(1)	C2(0)	C1(0)

REGISTER 5

RESERVED													LD PIN MODE	RESERVED													CONTROL BITS						
DB31	DB30	DB29	DB28	DB27	DB26	DB25	DB24	DB23	DB22	DB21	DB20	DB19		DB18	DB17	DB16	DB15	DB14	DB13	DB12	DB11	DB10	DB9	DB8	DB7	DB6	DB5	DB4	DB3	DB2	DB1	DB0	
0	0	0	0	0	0	0	0	D15	D14	0	0	0		0	0	0	0	0	0	0	0	0	0	0	0	0	0	0	0	0	0	C3(1)	C2(0)

¹ DBR = DOUBLE BUFFERED REGISTER—BUFFERED BY THE WRITE TO REGISTER 0.

Figure 18. Register Summary

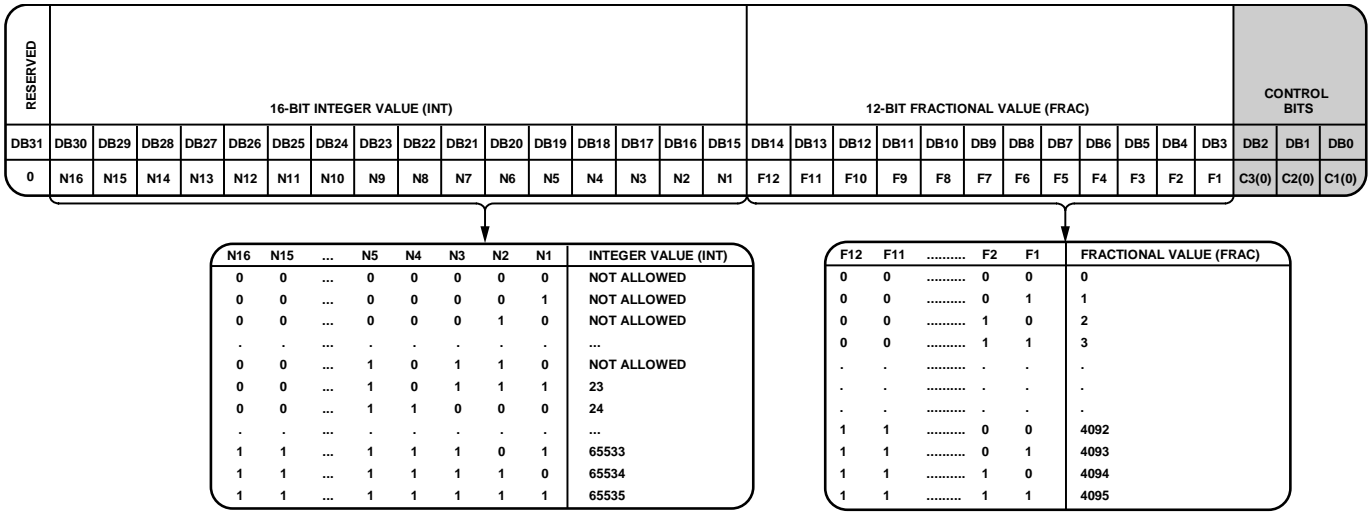

INTmin = 75 WITH PRESCALER = 8/9

Figure 19. Register 0 (R0)

10265-019

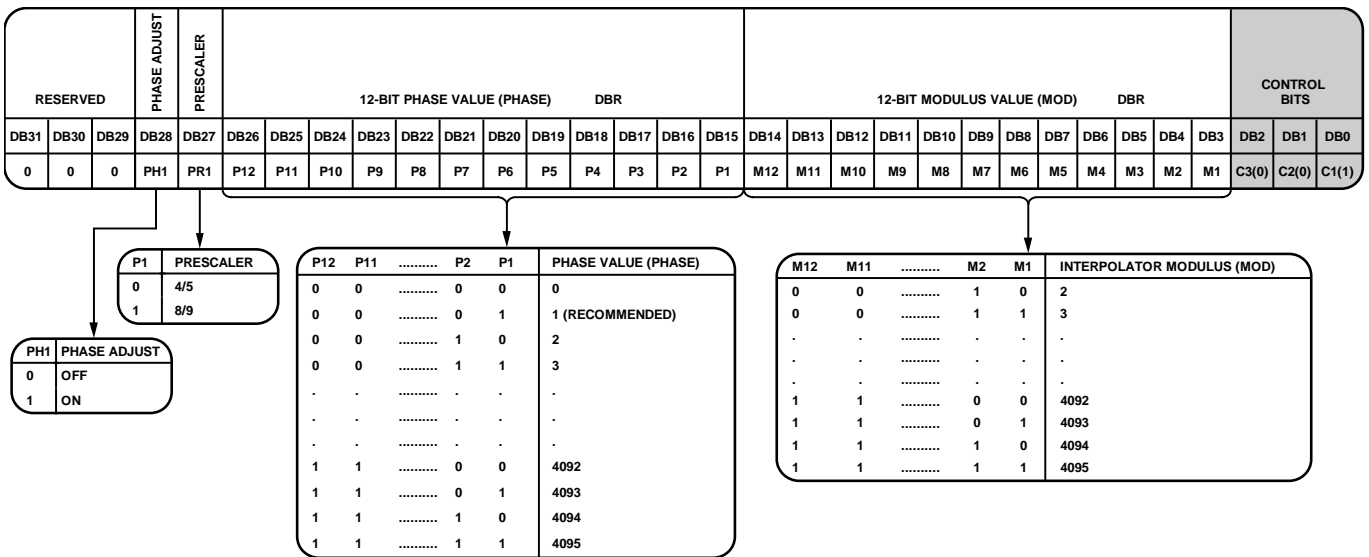

Figure 20. Register 1 (R1)

10265-020

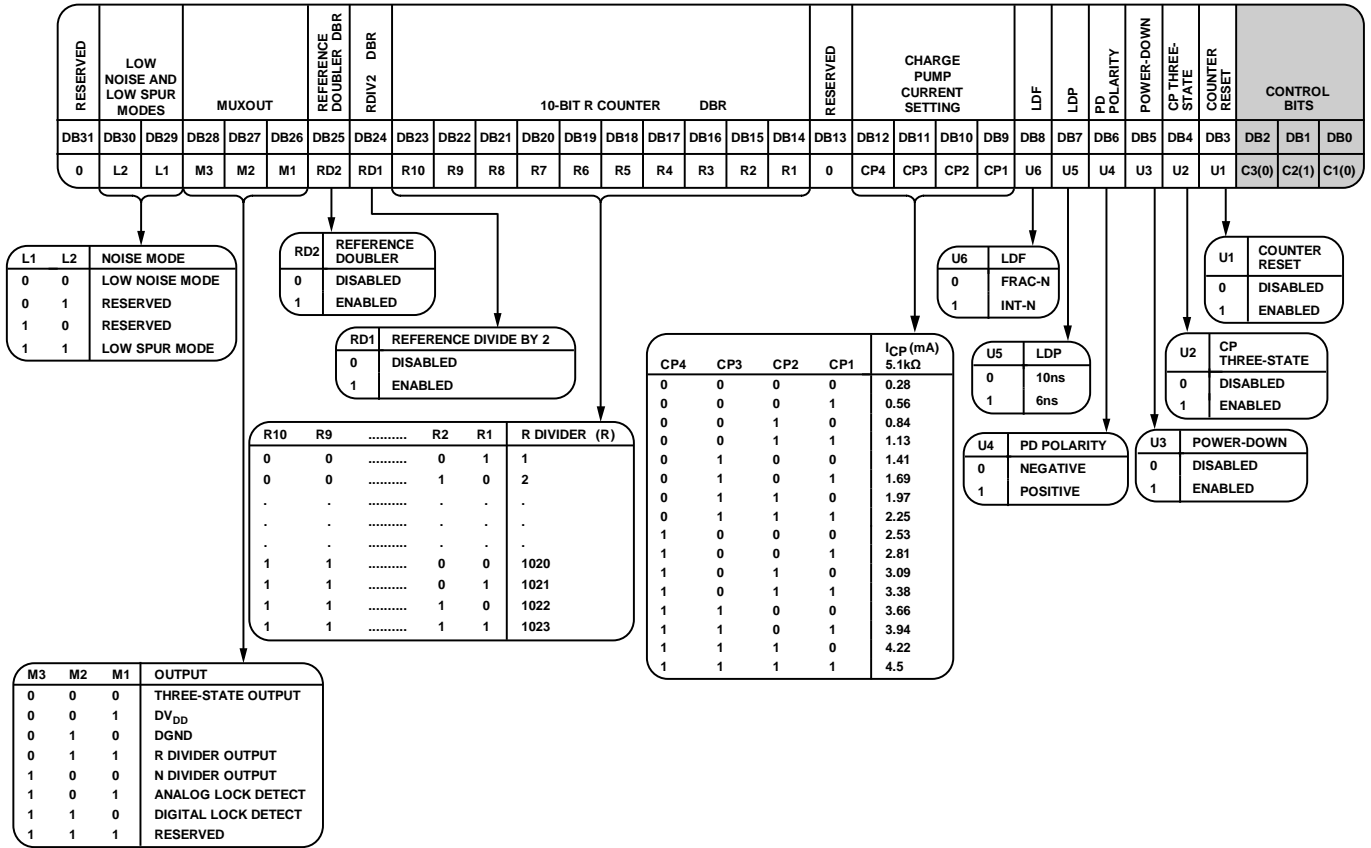

Figure 21. Register 2 (R2)

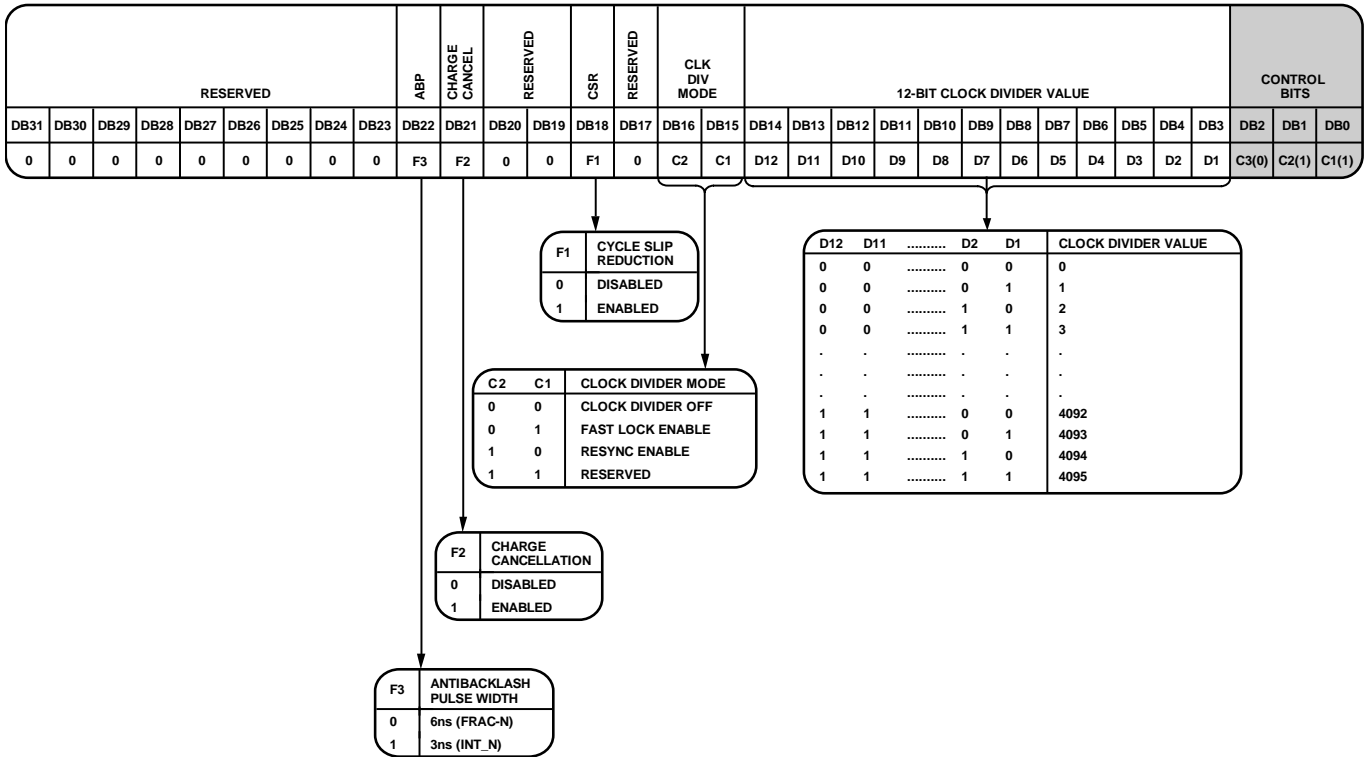

Figure 22. Register 3 (R3)

10285-022

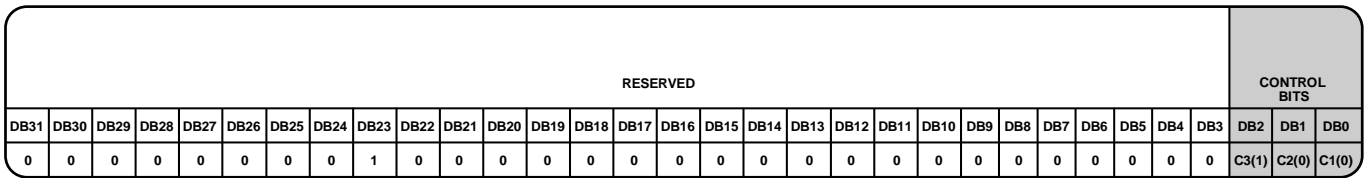

Figure 23. Register 4 (R4)

10285-023

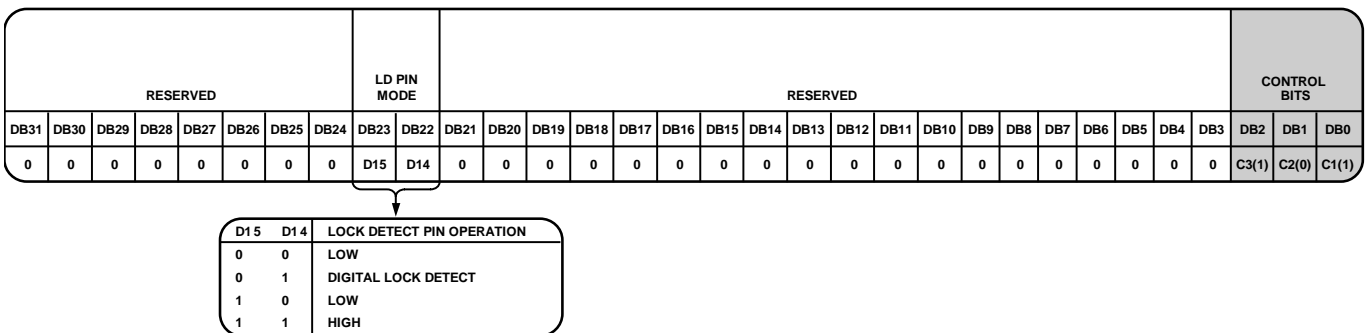

Figure 24. Register 5 (R5)

10285-024

REGISTER 0**Control Bits**

With Bits[C3:C1] set to 0, 0, 0, Register 0 is programmed. Figure 19 shows the input data format for programming this register.

16-Bit Integer Value (INT)

These 16 bits set the INT value, which determines the integer part of the feedback division factor. They are used in Equation 1 (see the INT, FRAC, MOD, and R Counter Relationship section). All integer values from 23 to 32,767 are allowed for 4/5 prescaler. For 8/9 prescaler, the minimum integer value is 75, and the maximum value is 65,535.

12-Bit Fractional Value (FRAC)

The 12 FRAC bits set the numerator of the fraction that is input to the Σ - Δ modulator. This, along with INT, specifies the new frequency channel that the synthesizer locks to, as shown in the RF Synthesizer—A Worked Example section. FRAC values from 0 to MOD – 1 cover channels over a frequency range equal to the PFD reference frequency.

REGISTER 1**Control Bits**

With Bits[C3:C1] set to 0, 0, 1, Register 1 is programmed. Figure 20 shows the input data format for programming this register.

Phase Adjust

The phase adjust bit, enabled by programming a 1 to DB28, permits adjustments to the output phase of a given output frequency. If enabled, it does not perform a phase resync function on updating R0. If set to 0, the phase resync (if enabled in R3, Bits[DB16:DB15]) occurs on every update of R0.

Prescaler Value

The dual modulus prescaler ($P/P + 1$), along with the INT, FRAC, and MOD counters, determines the overall division ratio from the VCO output to the PFD input.

Operating at CML levels, it takes the clock from the VCO output and divides it down for the counters. It is based on a synchronous 4/5 core. When set to 4/5, the maximum RF frequency allowed is 3 GHz. Therefore, when operating the ADF4151 above 3 GHz, this must be set to 8/9. The prescaler limits the INT value, where:

$$P = 4/5, N_{MIN} = 23$$

$$P = 8/9, N_{MIN} = 75$$

In the ADF4151, PR1 in Register 1 sets the prescaler values.

12-Bit Phase Value (PHASE)

These bits control what is loaded as the phase word. The word must be less than the MOD value programmed in Register 1. The word is used to program the RF output phase from 0° to 360° with a resolution of 360°/MOD. See the Phase Resync section for more information. In most applications, the phase relationship between the RF signal and the reference is not important. In such applications, the phase value can be used to optimize the fractional and subfractional spur levels. See the Spur Consistency and Fractional Spur Optimization section for more information.

If neither the phase resync nor the spurious optimization functions are being used, it is recommended that the phase word be set to 1.

12-Bit Modulus Value (MOD)

This programmable register sets the fractional modulus. This is the ratio of the PFD frequency to the channel step resolution on the RF output. See the RF Synthesizer—A Worked Example section for more information.

REGISTER 2**Control Bits**

With Bits[C3:C1] set to 0, 1, 0, Register 2 is programmed. Figure 21 shows the input data format for programming this register.

Low Noise and Spur Modes

The noise modes on the ADF4151 are controlled by DB30 and DB29 in Register 2 (see Figure 21). The noise modes allow the user to optimize a design either for improved spurious performance or for improved phase noise performance.

When the lowest spur setting is chosen, dither is enabled. This randomizes the fractional quantization noise so it resembles white noise rather than spurious noise. As a result, the part is optimized for improved spurious performance. This operation would normally be used when the PLL closed-loop bandwidth is wide, for fast locking applications. (Wide-loop bandwidth is seen as a loop bandwidth greater than 1/10 of the RF_{OUT} channel step resolution (f_{RES})). A wide loop filter does not attenuate the spurs to the same level as a narrow-loop bandwidth.

For best noise performance, use the lowest noise setting option. As well as disabling the dither, it also ensures that the charge pump is operating in an optimum region for noise performance. This setting is extremely useful where a narrow-loop filter bandwidth is available. The synthesizer ensures extremely low noise, and the filter attenuates the spurs. The typical performance characteristics give the user an idea of the trade-off in a typical W-CDMA setup for the different noise and spur settings.

MUXOUT

The on-chip multiplexer is controlled by Bits[DB28:DB26] (see Figure 21).

Reference Doubler

Setting DB25 to 0 feeds the REF_{IN} signal directly to the 10-bit R counter, disabling the doubler. Setting this bit to 1 multiplies the REF_{IN} frequency by a factor of 2 before feeding into the 10-bit R counter. When the doubler is disabled, the REF_{IN} falling edge is the active edge at the PFD input to the fractional synthesizer. When the doubler is enabled, both the rising and falling edges of REF_{IN} become active edges at the PFD input.

When the doubler is enabled and the lowest spur mode is chosen, the in-band phase noise performance is sensitive to the REF_{IN} duty cycle. The phase noise degradation can be as much as 5 dB for the REF_{IN} duty cycles outside a 45% to 55% range. The phase noise is insensitive to the REF_{IN} duty cycle in the lowest noise mode. The phase noise is insensitive to the REF_{IN} duty cycle when the doubler is disabled.

When the doubler is enabled, the maximum allowable REF_{IN} frequency is 30 MHz.

RDIV2

Setting the DB24 bit to 1 inserts a divide-by-2 toggle flip-flop between the R counter and PFD, which extends the maximum REF_{IN} input rate. This function allows a 50% duty cycle signal to appear at the PFD input, which is necessary for cycle slip reduction.

10-Bit R Counter

The 10-bit R counter allows the input reference frequency (REF_{IN}) to be divided down to produce the reference clock to the PFD. Division ratios from 1 to 1023 are allowed.

Current Setting

Bits[DB12:DB9] set the charge pump current setting. This should be set to the charge pump current that the loop filter is designed with (see Figure 21).

LDF

Setting DB8 to 1 enables integer-N digital lock detect, when the FRAC part of the divider is zero; setting DB8 to 0 enables fractional-N digital lock detect.

Lock Detect Precision (LDP)

When DB7 is set to 0, the fractional-N digital lock detect is activated. In this case after setting DB7 to 0, 40 consecutive PFD cycles of 10 ns must occur before digital lock detect is set. When DB7 is programmed to 1, 40 consecutive reference cycles of 6 ns must occur before digital lock detect goes high. Setting DB8 (LDF) to 1 causes the activation of the integer-N digital lock detect. In this case, after setting DB7 (LDP) to 0, five consecutive cycles of 10 ns must occur before digital lock detect is set. When DB7 is set to 1, five consecutive cycles of 6 ns must occur. Recommended settings of both the LDP and LDF bits are shown in Table 6.

Table 6. Recommended LDF/LDP Bit Settings

Mode	DB8 (LDF)	DB7 (LDP)
Integer-N	1	1
Fractional-N Low Noise Mode	0	1
Fractional-N Low Spur Mode	0	0

Phase Detector Polarity

DB6 sets the phase detector polarity. When a passive loop filter or noninverting active loop filter is used, set this bit to 1. If an active filter with an inverting characteristic is used, this bit should be set to 0.

Power-Down (PD)

DB5 provides the programmable power-down mode. Setting this bit to 1 performs a power-down. Setting this bit to 0 returns the synthesizer to normal operation. When in software power-down mode, the part retains all information in its registers. Only if the supply voltages are removed are the register contents lost.

When a power-down is activated, the following events occur:

- The synthesizer counters are forced to their load state conditions.
- The charge pump is forced into three-state mode.
- The digital lock detect circuitry is reset.
- The RF_{OUT} buffers are disabled.
- The input register remains active and capable of loading and latching data.

Charge Pump (CP) Three-State

DB4 puts the charge pump into three-state mode when programmed to 1. It should be set to 0 for normal operation.

Counter Reset

DB3 is the R counter and N counter reset bit for the ADF4151. When this bit is 1, the RF synthesizer N counter and R counter are held in reset. For normal operation, this bit should be set to 0.

REGISTER 3**Control Bits**

With Bits[C3:C1] set to 0, 1, 1, Register 3 is programmed. Figure 22 shows the input data format for programming this register.

Antibacklash Pulse Width

Setting DB22 to 0 sets the PFD antibacklash pulse width to 6 ns. This is the recommended mode for fractional-N use. By setting this bit to 1, the 3 ns pulse width is used and results in a phase noise and spur improvement in integer-N operation. For fractional-N mode it is not recommended to use this smaller setting.

Charge Cancellation Mode Pulse Width

Setting DB21 to 1 enables charge pump charge cancellation. This has the effect of reducing PFD spurs in integer-N mode. In fractional-N mode, this bit should not be used. This results in a phase noise and fractional spur improvement.

Cycle Slip Reduction (CSR) Enable

Setting DB18 to 1 enables cycle slip reduction. This is a method for improving lock times. Note that the signal at the phase frequency detector (PFD) must have a 50% duty cycle for cycle slip reduction to work. The charge pump current setting must also be set to a minimum. See the Cycle Slip Reduction for Faster Lock Times section for more information.

Clock Divider Mode

Bits[DB16:DB15] must be set to 1, 0 to activate phase resync or 0, 1 to activate fast lock. Setting Bits[DB16:DB15] to 0, 0 disables the clock divider. See Figure 22.

12-Bit Clock Divider Value

The 12-bit clock divider value sets the timeout counter for activation of phase resync. See the Phase Resync section for more information. It also sets the timeout counter for fast lock. See the Fast Lock Timer and Register Sequences section for more information.

REGISTER 4**Control Bits**

With Bits[C3: C1] set to 1, 0, 0, Register 4 is programmed. Figure 23 shows the input data format for programming this register.

This register is reserved and has to be programmed with the values as shown in Figure 23. Bits[DB31:DB24] and [DB22:DB3] must be programmed to 0, while Bit DB23 must be set to 1.

REGISTER 5**Control Bits**

With Bits[C3:C1] set to 1, 0, 1, Register 5 is programmed. Figure 24 shows the input data form for programming this register.

Lock Detect PIN Operation

Bits[DB23:DB22] set the operation of the lock detect pin (see Figure 24).

INITIALIZATION SEQUENCE

The following sequence of registers is the correct sequence for initial power up of the [ADF4151](#) after the correct application of voltages to the supply pins:

1. Register 5
2. Register 4
3. Register 3
4. Register 2
5. Register 1
6. Register 0

RF SYNTHESIZER—A WORKED EXAMPLE

The following is an example of how to program the ADF4151 synthesizer:

$$RF_{OUT} = [INT + (FRAC/MOD)] \times [f_{PFD}] / RF \text{ Divider} \quad (3)$$

where:

RF_{OUT} is the RF frequency output.

INT is the integer division factor.

$FRAC$ is the fractionality.

MOD is the modulus.

$RF \text{ Divider}$ is the output divider that divides down the VCO frequency.

$$f_{PFD} = REF_{IN} \times [(1 + D)/(R \times (1 + T))] \quad (4)$$

where:

REF_{IN} is the reference frequency input.

D is the RF REF_{IN} doubler bit.

R is the RF reference division factor.

T is the reference divide-by-2 bit (0 or 1).

For example, in a UMTS system, where 2112.6 MHz RF frequency output (RF_{OUT}) is required, a 10 MHz reference frequency input (REF_{IN}) is available, and a 200 kHz channel resolution (f_{RESOUT}) is required on the RF output. A 2.1 GHz VCO is suitable to cover the required fractional frequency of 2112.6 MHz.

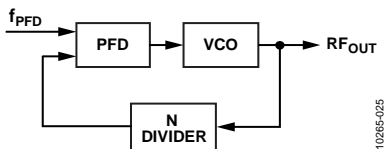

Figure 25. Loop Closed Before Output Divider

A channel resolution (f_{RES}) of 200 kHz is required at the output of the VCO.

$$MOD = REF_{IN} / f_{RES}$$

$$MOD = 10 \text{ MHz} / 200 \text{ kHz} = 50$$

From Equation 4

$$f_{PFD} = [10 \text{ MHz} \times (1 + 0)/1] = 10 \text{ MHz} \quad (5)$$

$$2112.6 \text{ MHz} = 10 \text{ MHz} \times (INT + FRAC/50) \quad (6)$$

where:

$INT = 211$

$FRAC = 13$

MODULUS

The choice of modulus (MOD) depends on the reference signal (REF_{IN}) available and the channel resolution (f_{RES}) required at the RF output. For example, a GSM system with 13 MHz REF_{IN} sets the modulus to 65. This means that the RF output resolution (f_{RES}) is the 200 kHz (13 MHz/65) necessary for GSM. With dither off, the fractional spur interval depends on the modulus values chosen (see Table 7).

REFERENCE DOUBLER AND REFERENCE DIVIDER

The reference doubler on chip allows the input reference signal to be doubled. This is useful for increasing the PFD comparison frequency. Making the PFD frequency higher improves the noise performance of the system. Doubling the PFD frequency usually improves noise performance by 3 dB. It is important to note that the PFD cannot operate above maximum value (see Table 1) due to a limitation in the speed of the Σ - Δ circuit of the N-divider.

The reference divide-by-2 divides the reference signal by 2, resulting in a 50% duty cycle PFD frequency. This is necessary for the correct operation of the cycle slip reduction (CSR) function. See the Cycle Slip Reduction for Faster Lock Times section for more information.

12-BIT PROGRAMMABLE MODULUS

Unlike most other fractional-N PLLs, the ADF4151 allows the user to program the modulus over a 12-bit range. This means that the user can set up the part in many different configurations for the application, when combined with the reference doubler and the 10-bit R counter.

For example, consider an application that requires 1.75 GHz RF and 200 kHz channel step resolution. The system has a 13 MHz reference signal.

One possible setup is feeding the 13 MHz directly to the PFD and programming the modulus to divide by 65. This results in the required 200 kHz resolution.

Another possible setup is using the reference doubler to create 26 MHz from the 13 MHz input signal. The 26 MHz is then fed into the PFD, programming the modulus to divide by 130. This also results in 200 kHz resolution and offers superior phase noise performance over the previous setup.

The programmable modulus is also very useful for multi-standard applications. If a dual-mode phone requires PDC and GSM 1800 standards, the programmable modulus is a great benefit. PDC requires 25 kHz channel step resolution, whereas GSM 1800 requires 200 kHz channel step resolution.

A 13 MHz reference signal can be fed directly to the PFD, and the modulus can be programmed to 520 when in PDC mode ($13 \text{ MHz}/520 = 25 \text{ kHz}$).

The modulus needs to be reprogrammed to 65 for GSM 1800 operation ($13 \text{ MHz}/65 = 200 \text{ kHz}$).

It is important that the PFD frequency remain constant (13 MHz). This allows the user to design one loop filter for both setups without running into stability issues. It is important to remember that the ratio of the RF frequency to the PFD frequency principally affects the loop filter design, not the actual channel spacing.

CYCLE SLIP REDUCTION FOR FASTER LOCK TIMES

As outlined in the Low Noise and Spur Mode section, the ADF4151 contains a number of features that allow optimization for noise performance. However, in fast locking applications, the loop bandwidth generally needs to be wide, and, therefore, the filter does not provide much attenuation of the spurs. If the cycle slip reduction feature is enabled, the narrow-loop bandwidth is maintained for spur attenuation but faster lock times are still possible.

Cycle Slips

Cycle slips occur in integer-N/fractional-N synthesizers when the loop bandwidth is narrow compared to the PFD frequency. The phase error at the PFD inputs accumulates too fast for the PLL to correct, and the charge pump temporarily pumps in the wrong direction. This slows down the lock time dramatically. The ADF4151 contains a cycle slip reduction feature that extends the linear range of the PFD, allowing faster lock times without modifications to the loop filter circuitry.

When the circuitry detects that a cycle slip is about to occur, it turns on an extra charge pump current cell. This outputs a constant current to the loop filter or removes a constant current from the loop filter (depending on whether the VCO tuning voltage needs to increase or decrease to acquire the new frequency). The effect is that the linear range of the PFD is increased. Loop stability is maintained because the current is constant and is not a pulsed current.

If the phase error increases again to a point where another cycle slip is likely, the ADF4151 turns on another charge pump cell. This continues until the ADF4151 detects that the VCO frequency has gone past the desired frequency. The extra charge pump cells are turned off one by one until all the extra charge pump cells have been disabled and the frequency is settled with the original loop filter bandwidth.

Up to seven extra charge pump cells can be turned on. In most applications, it is enough to eliminate cycle slips altogether, giving much faster lock times.

Setting Bit DB18 in the Register 3 to 1 enables cycle slip reduction. Note that the PFD requires a 45% to 55% duty cycle for CSR to operate correctly.

SPURIOUS OPTIMIZATION AND FAST LOCK

Narrow-loop bandwidths can filter unwanted spurious signals, but these usually have a long lock time. A wider loop bandwidth achieves faster lock times, but a wider loop bandwidth may lead to increased spurious signals inside the loop bandwidth.

The fast lock feature can achieve the same fast lock time as the wider bandwidth, but with the advantage of a narrow final loop bandwidth to keep spurs low.

FAST LOCK TIMER AND REGISTER SEQUENCES

If the fast lock mode is used, a timer value must be loaded into the PLL to determine the duration of the wide bandwidth mode.

When Bits[DB16:DB15] in Register 3 are set to 0, 1 (fast lock enable), the timer value is loaded by the 12-bit clock divider value. The following sequence must be programmed to use fast lock:

1. Initialization sequence (see the Initialization Sequence section); occurs only once after powering up the part.
2. Load Register 3 by setting Bits[DB16:DB15] to 0, 1 and the chosen fast lock timer value, Bits[DB14:DB3]. Note that the length of time the PLL remains in wide bandwidth is equal to the fast lock timer/ f_{PFD} .

FAST LOCK—AN EXAMPLE

If a PLL has a reference frequency of 13 MHz, a f_{PFD} of 13 MHz and a required lock time of 50 μ s, the PLL is set to wide bandwidth for 40 μ s. This example assumes a modulus of 65 for channel spacing of 200 kHz.

If the time period set for the wide bandwidth is 40 μ s, then

$$\text{Fast Lock Timer Value} = \text{Time In Wide Bandwidth} \times f_{PFD}/\text{MOD}$$

$$\text{Fast Lock Timer Value} = 40 \mu\text{s} \times 13 \text{ MHz}/65 = 8$$

Therefore, 8 must be loaded into the clock divider value in Register 3 in Step 1 of the sequence described in the Fast Lock Timer and Register Sequences section.

FAST LOCK—LOOP FILTER TOPOLOGY

To use fast lock mode, the damping resistor in the loop filter is reduced to 1/4 of its value while in wide bandwidth mode. To achieve the wider loop filter bandwidth, the charge pump current increases by a factor of 16. To maintain loop stability, the damping resistor must be reduced a factor of 1/4. To enable fast lock, the SW pin is shorted to the GND pin by setting Bits[DB16:DB15] in Register 3 to values 0, 1. The following two topologies are available:

- The damping resistor (R1) is divided into two values (R1 and R1A) that have a ratio of 1:3 (see Figure 26).
- An extra resistor (R1A) is connected directly from SW, as shown in Figure 27. The extra resistor is calculated such that the parallel combination of an extra resistor and the damping resistor (R1) is reduced to 1/4 of the original value of R1 (see Figure 27).

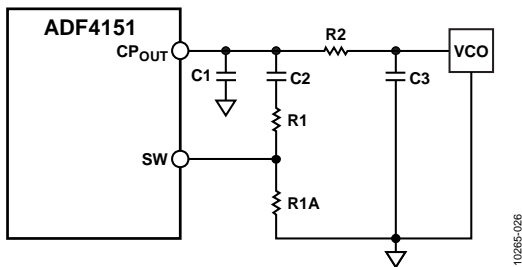

Figure 26. Fast Lock Loop Filter Topology—Topology 1

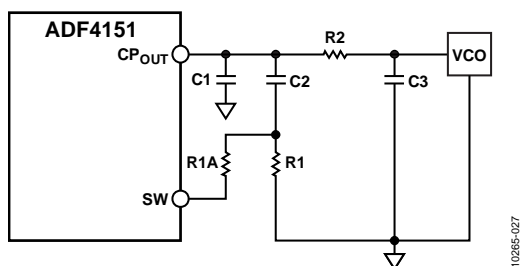

Figure 27. Fast Lock Loop Filter Topology—Topology 2

SPUR MECHANISMS

This section describes the three different spur mechanisms that arise with a fractional-N synthesizer and how to minimize them in the ADF4151.

Fractional Spurs

The fractional interpolator in the ADF4151 is a third-order Σ - Δ modulator (SDM) with a modulus (MOD) that is programmable to any integer value from 2 to 4095. In low spur mode (dither enabled), the minimum allowable value of MOD is 50. The SDM is clocked at the PFD reference rate (f_{PFD}) that allows PLL output frequencies to be synthesized at a channel step resolution of f_{PFD}/MOD .

In low noise mode (dither off), the quantization noise from the Σ - Δ modulator appears as fractional spurs. The interval between spurs is f_{PFD}/L , where L is the repeat length of the code sequence in the digital Σ - Δ modulator. For the third-order modulator used in the ADF4151, the repeat length depends on the value of MOD, as listed in Table 7.

Table 7. Fractional Spurs with Dither Off

Condition (Dither Off)	Repeat Length	Spur Interval
If MOD is divisible by 2, but not 3	$2 \times \text{MOD}$	Channel step/2
If MOD is divisible by 3, but not 2	$3 \times \text{MOD}$	Channel step/3
If MOD is divisible by 6	$6 \times \text{MOD}$	Channel step/6
Otherwise	MOD	Channel step

In low spur mode (dither on), the repeat length is extended to 2^{21} cycles, regardless of the value of MOD, which makes the quantization error spectrum look like broadband noise. This may degrade the in-band phase noise at the PLL output by as much as 10 dB. For lowest noise, dither off is a better choice, particularly when the final loop bandwidth is low enough to attenuate even the lowest frequency fractional spur.

Integer Boundary Spurs

Another mechanism for fractional spur creation is the interactions between the RF VCO frequency and the reference frequency. When these frequencies are not integer related (the point of a fractional-N synthesizer) spur sidebands appear on the VCO output spectrum at an offset frequency that corresponds to the beat note or difference frequency between an integer multiple of the reference and the VCO frequency. These spurs are attenuated by the loop filter and are more noticeable on channels close to integer multiples of the reference where the difference frequency can be inside the loop bandwidth; therefore, the name integer boundary spurs.

Reference Spurs

Reference spurs are generally not a problem in fractional-N synthesizers because the reference offset is far outside the loop bandwidth. However, any reference feedthrough mechanism that bypasses the loop can cause a problem. Feedthrough of low levels of on-chip reference switching noise, through the RF_{IN} pin back to the VCO, can result in reference spur levels as high as -90 dBc. PCB layout must ensure adequate isolation between VCO traces and the input reference to avoid a possible feedthrough path on the board.

SPUR CONSISTENCY AND FRACTIONAL SPUR OPTIMIZATION

With dither off, the fractional spur pattern due to the quantization noise of the SDM also depends on the particular phase word with which the modulator is seeded.

The phase word can be varied to optimize the fractional and subfractional spur levels on any particular frequency. Thus, a look-up table of phase values corresponding to each frequency can be constructed for use when programming the ADF4151.

If a look-up table is not used, keep the phase word at a constant value to ensure consistent spur levels on any particular frequency.

PHASE RESYNC

The output of a fractional-N PLL can settle to any one of the MOD phase offsets with respect to the input reference, where MOD is the fractional modulus. The phase resync feature in the ADF4151 produces a consistent output phase offset with respect to the input reference. This is necessary in applications where the output phase and frequency are important, such as digital beam forming. See the Phase Programmability section for how to program a specific RF output phase when using phase resync.

Phase resync is enabled by setting Bit DB16, Bit DB15 in Register 3 to 1, 0. When phase resync is enabled, an internal timer generates sync signals at intervals of t_{SYNC} given by the following formula:

$$t_{\text{SYNC}} = \text{CLK_DIV_VALUE} \times \text{MOD} \times t_{\text{PFD}}$$

where:

CLK_DIV_VALUE is the decimal value programmed in Bits[DB14:DB3] of Register 3 and can be any integer in the range of 1 to 4095.

MOD is the modulus value programmed in Bits[DB14:DB3] of Register 1 (R1).

t_{PFD} is the PFD reference period.

When a new frequency is programmed, the second sync pulse after the LE rising edge is used to resynchronize the output phase to the reference. The t_{SYNC} time must be programmed to a value that is at least as long as the worst-case lock time. This guarantees that the phase resync occurs after the last cycle slip in the PLL settling transient.

In the example shown in Figure 28, the PFD reference is 25 MHz and MOD is 125 for a 200 kHz channel spacing. t_{SYNC} is set to 400 μs by programming the clock divider value, CLK_DIV_VALUE , to 80.

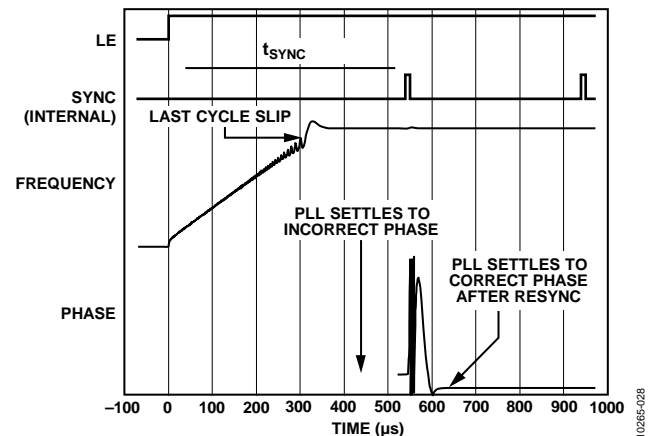

Figure 28. Phase Resync Example

Phase Programmability

The phase word in Register 1 controls the RF output phase. As this word is swept from 0 to MOD, the RF output phase sweeps over a 360° range in steps of 360°/MOD.

INTERFACING

The ADF4151 has a simple SPI-compatible serial interface for writing to the device. CLK, DATA, and LE control the data transfer. When LE goes high, the 32 bits that have been clocked into the appropriate register on each rising edge of CLK are transferred to the appropriate latch. See Figure 2 for the timing diagram and Table 5 for the register address table.

ADuC812 Interface

Figure 30 shows the interface between the ADF4151 and the ADuC812 MicroConverter®. Because the ADuC812 is based on an 8051 core, this interface can be used with any 8051-based microcontroller. The MicroConverter is set up for SPI master mode with CPHA = 0. To initiate the operation, the I/O port driving LE is brought low. Each latch of the ADF4151 needs a 32-bit word, which is accomplished by writing four 8-bit bytes from the MicroConverter to the device. When the fourth byte has been written, the LE input should be brought high to complete the transfer.

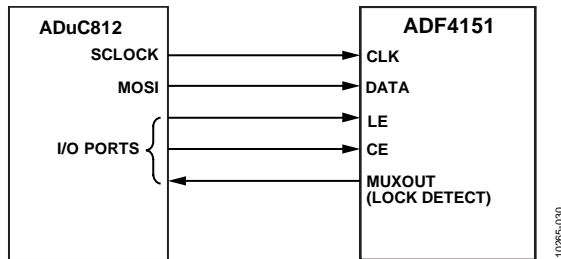

Figure 30. ADuC812 to ADF4151 Interface

I/O port lines on the ADuC812 are also used to control power-down (CE input) and detect lock (MUXOUT configured as lock detect and polled by the port input). When operating in the described mode, the maximum SCLOCK rate of the ADuC812 is 4 MHz. This means that the maximum rate at which the output frequency can be changed is 125 kHz.

Blackfin BF527 Interface

Figure 31 shows the interface between the ADF4151 and the Blackfin ADSP-BF527 digital signal processor (DSP). The ADF4151 needs a 32-bit serial word for each latch write. The easiest way to accomplish this using the Blackfin family is to use the autobuffered transmit mode of operation with alternate framing. This provides a means for transmitting an entire block of serial data before an interrupt is generated. Set up the word length for eight bits and use four memory locations for each 32-bit word. To program each 32-bit latch, store the four 8-bit bytes, enable the autobuffered mode, and write to the transmit register of the DSP. This last operation initiates the autobuffer transfer. As in the microcontroller case, just make sure that the clock speeds are within the maximum limits outlined in Table 2.

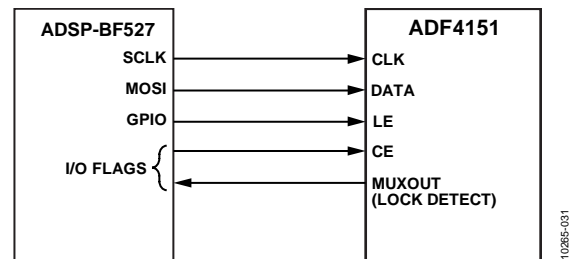

Figure 31. ADSP-BF527 to ADF4151 Interface

PCB DESIGN GUIDELINES FOR CHIP SCALE PACKAGE

The lands on the chip scale package (CP-32-7) are rectangular. The PCB pad for these must be 0.1 mm longer than the package land length and 0.05 mm wider than the package land width. The land is to be centered on the pad. This ensures that the solder joint size is maximized. The bottom of the chip scale package has a central thermal pad.

The thermal pad on the PCB must be at least as large as the exposed pad. On the PCB, there is to be a minimum clearance of 0.25 mm between the thermal pad and the inner edges of the pad pattern. This ensures that shorting is avoided.

Thermal vias can be used on the PCB thermal pad to improve the thermal performance of the package. If vias are used, they are to be incorporated in the thermal pad at 1.2 mm pitch grid. The via diameter must be between 0.3 mm and 0.33 mm, and the via barrel must be plated with one ounce copper to plug the via.

OUTLINE DIMENSIONS

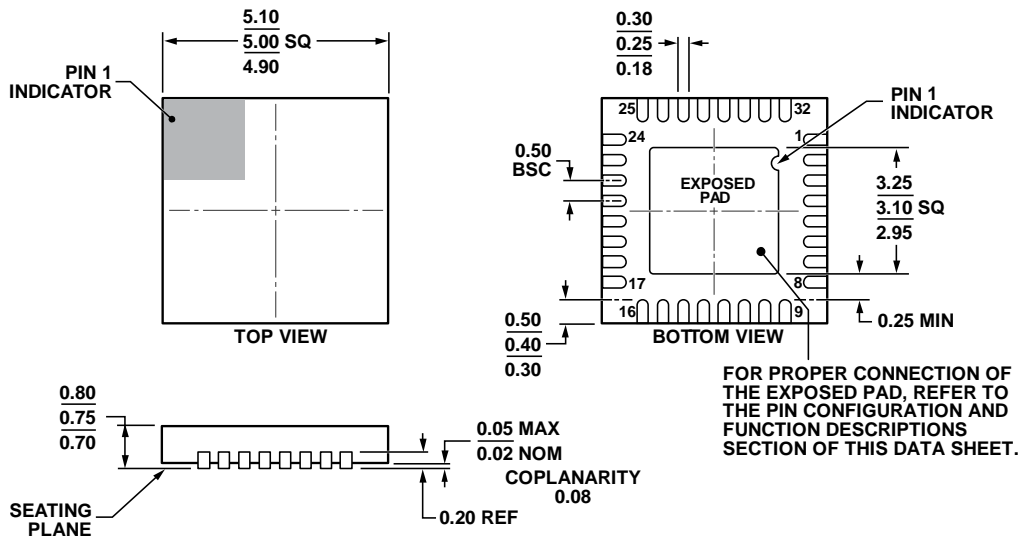

COMPLIANT TO JEDEC STANDARDS MO-220-WHHD.

Figure 32. 32-Lead Lead Frame Chip Scale Package [LFCSP_WQ]
 5 mm × 5 mm Body, Very Thin Quad
 (CP-32-7)
 Dimensions shown in millimeters

112408-A

ORDERING GUIDE

Model ¹	Temperature Range	Package Description	Package Option
ADF4151BCPZ	-40°C to +85°C	32-Lead Lead Frame Chip Scale Package [LFCSP_WQ]	CP-32-7
ADF4151BCPZ-RL7	-40°C to +85°C	32-Lead Lead Frame Chip Scale Package [LFCSP_WQ]	CP-32-7
EVAL-ADF4151EB1Z		Evaluation Board	

¹ Z = RoHS Compliant Part.

NOTES

NOTES